

SDA2-E Series servo system

EtherCAT Application manual



SDA2 Series Servo System (motor & drive)

EtherCAT Application manual

File No. 520001302810

Vision No. V1.0

Filing time 2025-03-06

SAVCH electric provide a full range of technical support for our customers.

All users could contact with the nearest SANCH office or service center,
also could contact with our headquarters directly.

SAVCH Electric reserves the copyrights and all rights,

Subject to change without further notice.

CONTENTS

Preface	- 1 -
Chapter1 Overview	- 1 -
Chapter 2 System Configuration	- 2 -
2.1 EtherCAT port	- 2 -
2.2 Indicator	- 2 -
2.2.1 Network status indicator	- 2 -
2.2.2 ESM status indicator	- 3 -
2.2.3 Error indicator	- 3 -
2.3 Operation panel indication	- 3 -
2.4 IO Terminal CN3	- 4 -
2.5 Parameter setting	- 5 -
Chapter3 EtherCAT Communication	- 7 -
3.1 Communication structure	- 7 -
3.2 EtherCAT state machine	- 8 -
3.3 SDO	- 9 -
3.4 PDO	- 9 -
3.5 Synchronous mode	- 10 -
3.5.1 DC Synchronization Mode	- 10 -
3.5.2 Free run mode	- 11 -
3.6 Emergency object	- 11 -
3.7 Addressing mode	- 11 -
Chapter4 Operation	- 12 -
4.1 Control state machine	- 12 -
4.1.1 CiA402 state machine	- 12 -
4.1.2 Control words	- 13 -
4.1.3 Status word	- 14 -
4.2 Profile position mode	- 15 -
4.3 Cycle Synchronized Position Mode	- 17 -
4.4 Homing Mode	- 18 -
4.5 Profile Velocity Mode	- 21 -
4.6 Cycle Synchronized Speed mode	- 22 -
4.7 Profile Torque Mode	- 24 -
4.8 Cycle Synchronized Torque Mode	- 25 -
4.9 Other mode	- 26 -
4.9.1 Position Touch Probe	- 26 -

Chapter 5 Troubleshooting	- 28 -
5.1 Error code	- 28 -
5.2 EtherCAT Associated error details	- 29 -
5.3 SDO Abort code	- 33 -
Chapter6 Object Dictionary	- 34 -
6.1 Communication parameter object	- 34 -
6.2 Sub-protocol object	- 37 -
6.3 Servo specific object	- 39 -
6.3.1 Parameters	- 41 -
6.3.2 Monitoring data	- 41 -
6.3.3 Alarm record	- 41 -
6.3.4 Communication digital terminal	- 41 -

Preface

Thank you very much for choosing SAVCH servo drive! The instructions for using the servo driver are not described in this manual. Please read this manual and the instruction manual of the servo driver before use and understand how to use it properly. Improper use will prevent proper operation, reduce service life and cause malfunctions.

Please keep the instruction manual safe after use.

Chapter1 Overview

Table1-1 Communication specification

Item	Specification
Physical layer	100BASE-TX
Communication connector	RJ45×2(input: CN4; output: CN5)
Baud rate	2x100Mbps(full duplex)
Frame data length	Maximum 1484 bytes
Sync manager	SM0:Mailbox output SM1:Mailbox input SM2:Process data output SM3:Process data input
FMMU (Fieldbus memory management units)	FMMU0:Process data output area FMMU1:Process data input area FMMU2:Mailbox status area
Sync mode	DC Synchronization(DC SYNC0) Free Run
Communication object	SDO:Service data object PDO:Process data object EMCY:Emergency data object
Application layer protocol	CoE:CANopen over EtherCAT
Application layer specification	IEC61800-7 CiA402 Drive Profile
The supported CiA402 operation modes	Profile Position Mode(PP) Profile Velocity Mode(PV) Profile Torque Mode(PT) Homing Mode(HM) Cycle Synchronized Position Mode(CSP) Cycle Synchronized Velocity Mode(CSV) Cycle Synchronized Torque Mode(CST)

Chapter 2 System Configuration

2.1 EtherCAT port

The dual RJ45 terminal of the SDA2 E series servo drive is located at CN4 and CN5. CN4 is the EtherCAT network input port, and CN5 is the network output port.

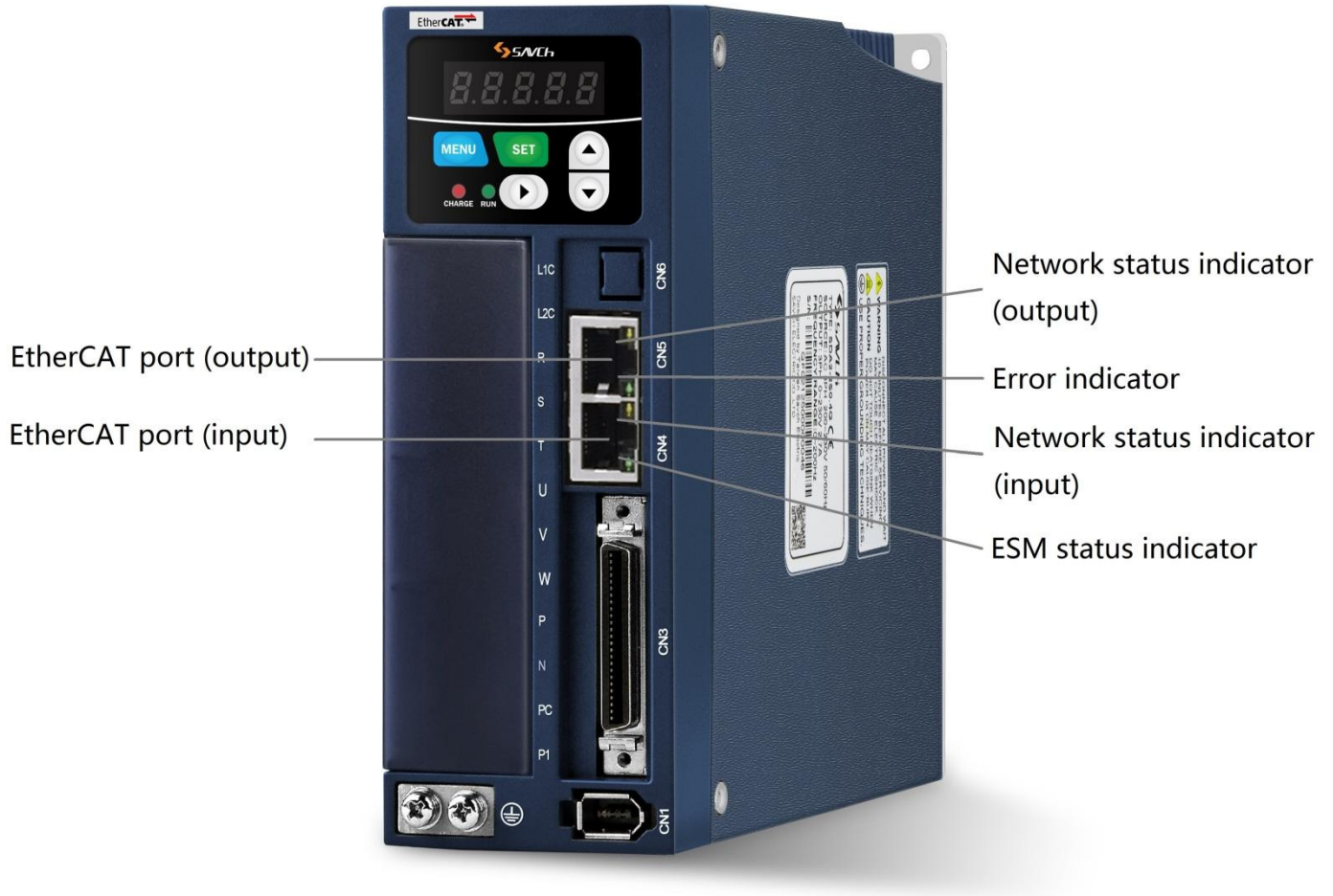

Figure 2-1 Names of EtherCAT port component

Note: Please use CAT5e STP Shielding wire.

2.2 Indicator

2.2.1 Network status indicator

The signal status of the network status indicator shows the status of the connection and data transmission. The corresponding status is shown in the table below.

Indicator status	Description
OFF	Network not connected
Blinking	The network is connected and the data is under transmission
ON	The network is connected but without data transmission

2.2.2 ESM status indicator

The ESM status indicator shows the status of the current servo EtherCAT state machine. The corresponding status is as follows:

Indicator status	Corresponding status of ESM	Description
OFF	Initialization	Only transmit ESC register data
Blinking	Pre-Operational	It Can transmit SDO data
Single flash	Safe-Operational	It can transmit SDO and TxPDO
ON	Operational	It can transmit SDO, TxPDO and RxPDO

2.2.3 Error indicator

Indicates the current error status (only indicates the EtherCAT related error status). The corresponding status is as follows:

Indicator status	Error status	Description
OFF	No communication error	No communication related errors occur
Blinking	Abnormal communication setting	EEPROM loading error or network disconnection during communication
Single flash	Synchronize error	Synchronization related error occurs
ON	PDI error	Abnormal PDI communication

2.3 Operation panel indication

The E series servo drive will display the EtherCAT related status after power-on (the initial display can be changed by parameter P2.77). The displayed status is divided into three types, separated by decimal point, including ESM status, CiA402 operation mode and servo operation status. The specific meaning is as shown below:

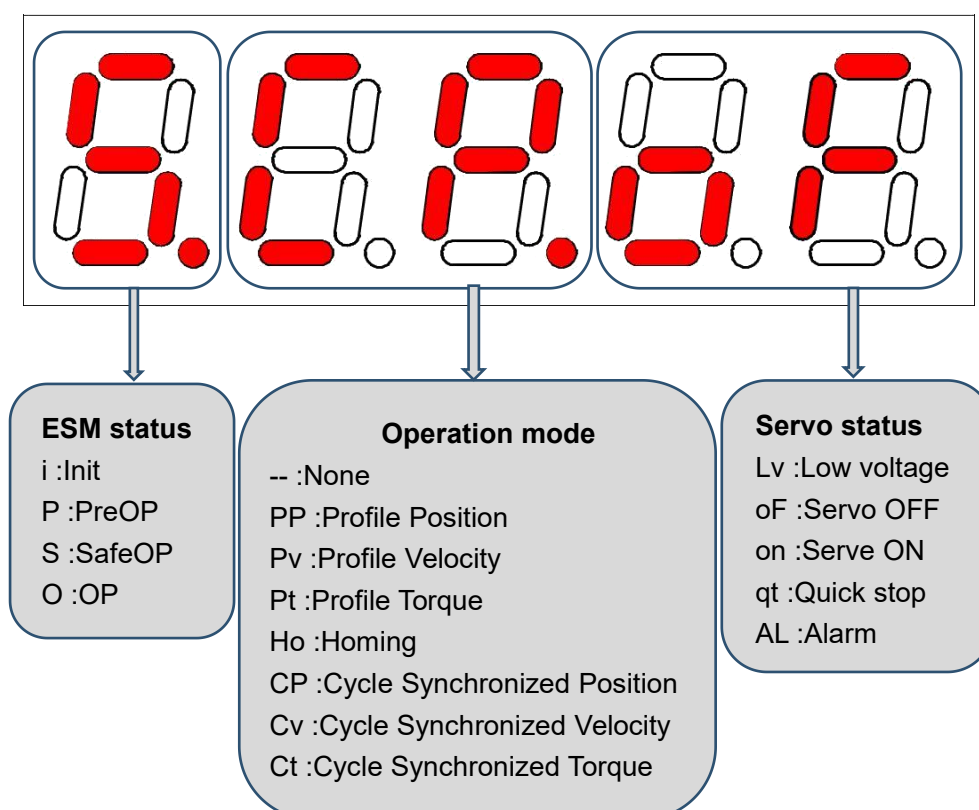

2.4 IO Terminal CN3

In addition to EtherCAT communication, SDA2 servo driver also provides IO terminal connection with other devices. The connection of IO terminal is carried out through a 50pin connector. The layout of the plug is as follows:

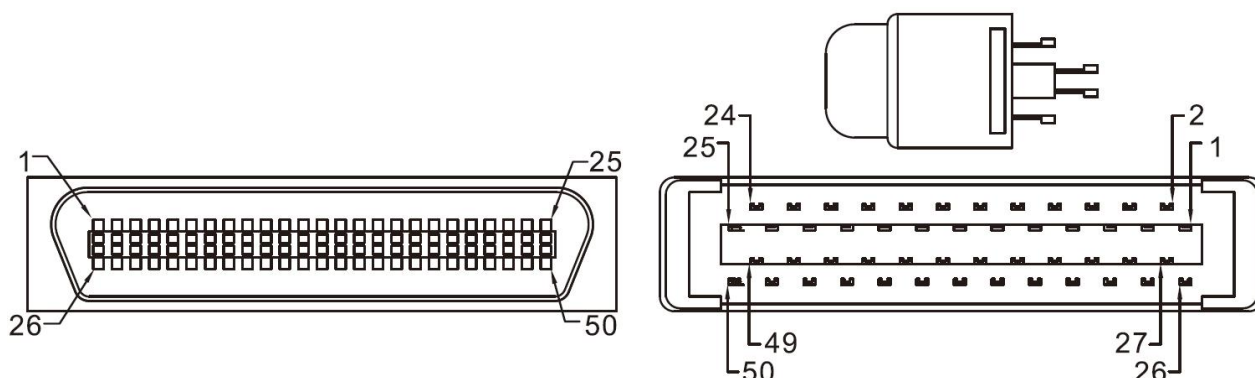

The specific functions of the signal are shown in the table below.

Signal		Pin.NO	Function		
Digital input	EI1	Digital input terminal 1	43	EI input terminal (corresponding to the drain/source signal) A terminal for inputting a command signal to the servo driver. DC12 [V]~24 [V]/8 [mA] (per 1 point). The optocoupler is insulated. The common terminal is the COM terminal. * Where EI6 and EI7 can be used as trigger signals for position probe function.	
	EI2	Digital input terminal 2	41		
	EI3	Digital input terminal 3	39		
	EI4	Digital input terminal 4	6		
	EI5	Digital input terminal 5	7		
	EI6	Digital input terminal 6	8		
	EI7	Digital input terminal 7	9		
	EI8	Digital input terminal 8	10		
	COM	Common input terminal	12		
Digital output	EOUT1	Digital output terminal 1	13	EOUT output terminal (corresponding to the drain/source signal) Signal output terminal from servo drive. Maximum DC24 [V]/50 [mA]. The optocoupler is insulated. The common terminal is the COM terminal.	
	EOUT2	Digital output terminal 2	14		
	EOUT3	Digital output terminal 3	15		
	EOUT4	Digital output terminal 4	16		
	EOUT5	Digital output terminal 5	17		
	OCM	Common output terminal	18		
Encode signal output	OA+	Encoder A phase signal	35	Encoder A phase differential signal output.	When the servo motor rotates forward, the encoder B phase pulse is delayed by 90° from the phase of the A phase pulse, it can be adjusted by parameter P1.11.
	OA-		34		
	OB+	Encoder B phase signal	29	Encoder B phase differential signal output	
	OB-		30		
	OZ+	Encoder Z phase signal	32	Encoder Z signal differential output	
	OZ-		31		
	OOA	Encoder A phase signal	27	Encoder A signal collector open output.	
	OOB	Encoder B phase signal	28	Encoder B signal collector open output.	
	OOZ	Encoder Z phase signal	33	Encoder Z signal collector open output.	

Signal			Pin.NO	Function
Power supply	IP24	Internal isolated power supply	37	Internal isolated power supply +24V output
	IG24	GND Internal isolated power supply	38	Internal isolated power supply +24V ground
	GND	Internal GND	26,47,49	Internal grounded
	NC	unused	-	Please do not connect due to unused

2.5 Parameter setting

SDA2 EtherCAT related parameter setting is as below:

Para No.	Para name	Setting range	Default value	Description
P1.01	Servo mode	0~9	9	EtherCAT mode
P2.25	Position command format	0: Normal PTP 1: Infinite length	0	The servo motor position is limited to the range set by the object dictionary 0x607D
P2.77	Initial display of the keypad	0~42 0: Action mode 1: Feedback speed 2: Command speed 3: Command torque 4: Motor current 5: Peak torque 6: Effective torque 7: Feedback position 8: Command position 9: Position deviation 11: Feedback cumulative pulse 13: LS-Z pulse 14: Load inertia ratio 15: DC link voltage (max.) 16: DC link voltage (min.) 19: Input signals 20: Output signals 21: OL thermal value 29: EtherCAT status 41: Alarm at present 42: Alarm history	29	The initial display after servo power-on is EtherCAT status
P3.89	Feedback speed sampling time	0: 62.5 [us] 1: 125 [us] 2: 250 [us] 3: 500 [us] 4: 1 [ms] 5: 2 [ms] 6: 4 [ms] 7: 8 [ms]	1	Set the sampling time of the feedback speed to the object dictionary is 606ch.
P4.01	ECAT node ID	1~65535	1	Set node ID

Para No.	Para name	Setting range	Default value	Description
P4.02	ECAT node ID setting	0: Set the node ID according to the value of the EEPROM 1: Set the node ID according to the value of parameter P4.01	0	Set node ID according to EEPROM
P4.03	Data synchronization Detection setting	0: no detection 1~99: Data loss alarm occurs when the setting data is lost continuously	0	Synchronized data detection setting under the Cycle Synchronized Mode
P4.04	Data Loss Processing Settings	0: no processing 1: Update the position command with the last interpolation data increment value	1	Processing settings when position data is lost in the cycle sync position mode
P4.05	Speed command format	0: rpm 1: uint/s	0	Adjust the format of speed related commands * Supported after version ID (OD 0x1018 sub 03) is 0x00190013
P4.09	Input shift time setting	0~160 Input shift time = 26000 + the parameter value*62500	0	Adjust input shift time

Note: All the above parameters need to be re-powered by the servo to take effect.

Chapter3 EtherCAT Communication

3.1 Communication structure

There are a variety of application layer protocols for using EtherCAT communication. In the SDA2 servo drive, the IEC 61800-7 (CiA402)-CANopen motion control sub-protocol is used.

The figure below shows the EtherCAT communication structure based on the CANopen application layer.

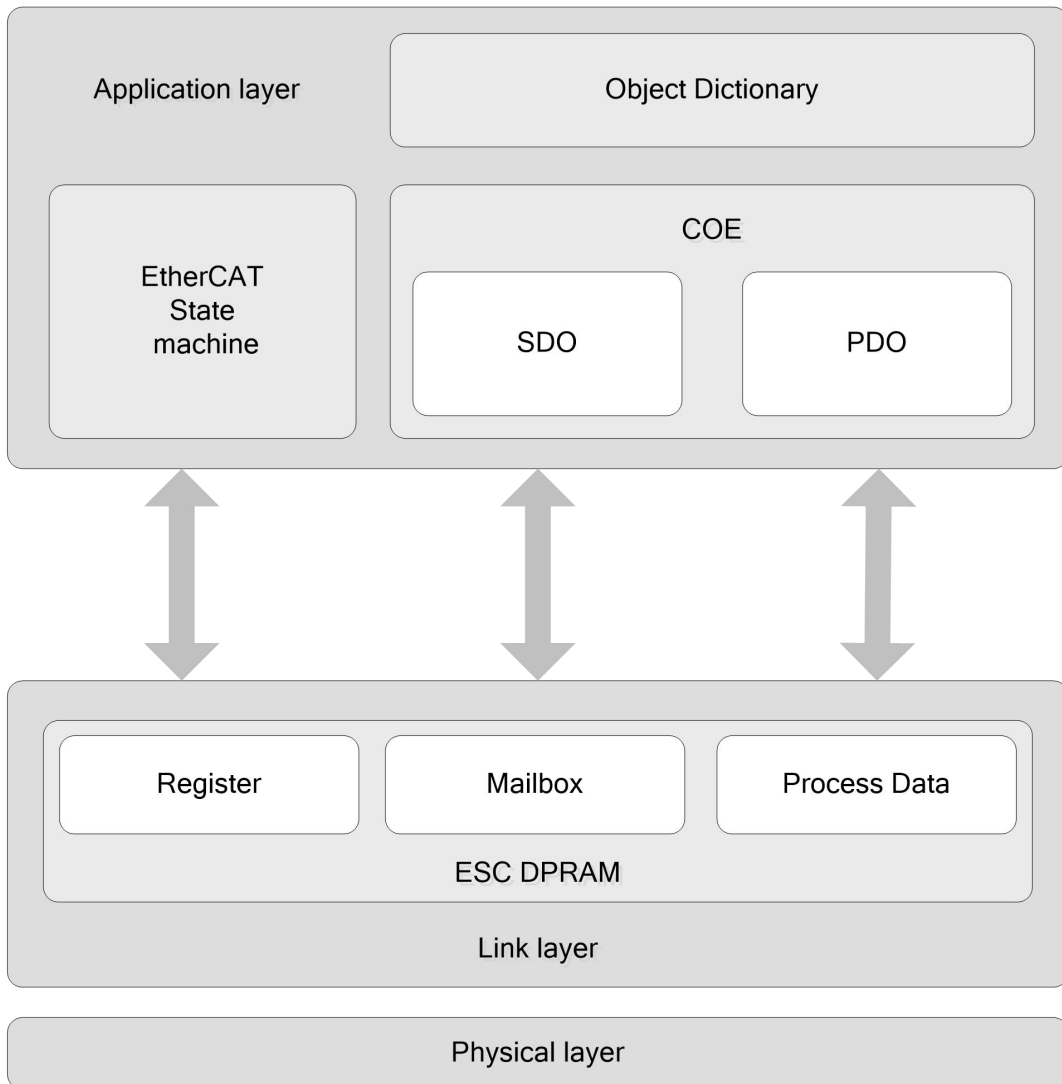

Figure3-1 Communication structure

In the structure diagram, the application layer object dictionary contains: communication parameters, application data, and PDO mapping data. The PDO process data object contains real-time data during the operation of the servo drive and is periodically read and written. SDO mailbox communication, access modification is performed on some communication parameter objects and PDO process data objects in a non-periodic manner.

3.2 EtherCAT state machine

The EtherCAT device must support four states and is responsible for coordinating the state relationship between the master and slave applications during initialization and runtime.

The following is a block diagram of the EtherCAT state transition:

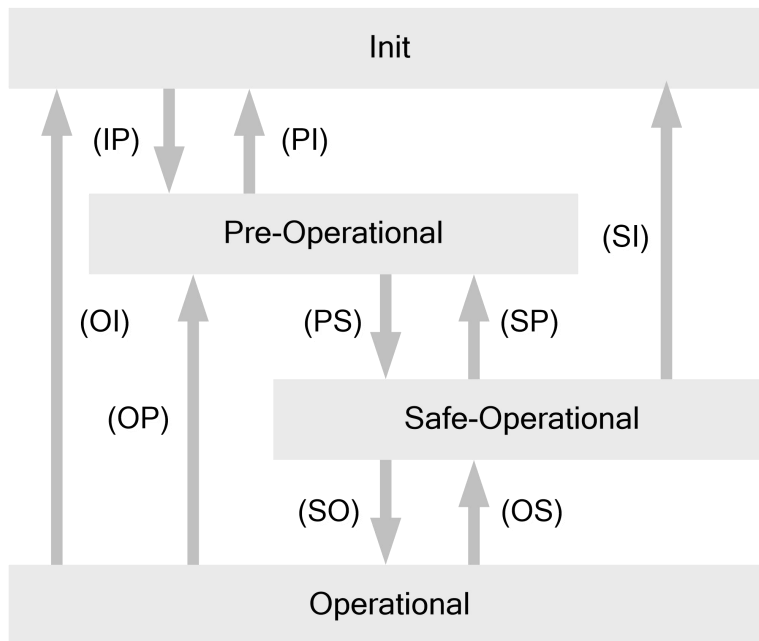

Figure3-2 Node state transition diagram

When converting from the initial state to the running state, it must be converted in the order of "Initialization -> Pre-OP -> Safe OP -> OP", and it cannot be overridden. It can be converted in level when returning from the running state.

The state conversion operation and initialization process are as follows:

State and state conversion	Operation
Init	The application layer has no communication, the master can only read and write the ESC register.
I->P conversion	Configure the mailbox ; Request a "Pre-Operational" .
Pre-Operational	It is available of application layer mailbox data communication.(SDO)
P->S conversion	The master station uses the mailbox initialization process data mapping; The SM channel used by the master station to configure the process data communication; Configure synchronization parameters; Request "Safe-Operational".
Safe-Operational	There is process data communication, but only input data is allowed to be read, and no output signal is generated. (SDO、 TPDO)
S->O conversion	The master station sends valid output data; Request "Operational".
Operational	All communication objects are valid (SDO、 TPDO、 RPDO)

3.3 SDO

SDO is used to transmit acyclic data, through the CoE protocol of EtherCAT mailbox to access all object dictionary supported by the device. SDO will receive the information returned by the device when accessing. When an access exception occurs, the device will return the abort code, and the cause of the exception can be confirmed according to the abort code.

SDA2 E-Series servo drives support SDO communication and SDO information access. The SDO communication is used to transmit the data of the object dictionary, and the SDO information access is used to obtain information such as the number of supported objects, the name, the number of data bits, and the read and write attributes.

- Note
1. SDO access needs to wait for the servo drive to be ready to receive the returned data.
 2. The object dictionary mapped to RxPDO cannot be updated by SDO, and the value written by SDO will be overwritten by the value written by PDO.

3.4 PDO

Process Data Objects (PDO) are used to transmit real-time data, from producer to consumer, and can be divided into RPDO and TPDO, depending on the reception and transmission. In EtherCAT process data communication, the process data can contain multiple PDO mapping data objects. The data objects 0x1C10 ~ 0x1C2F used by the CoE protocol define the corresponding SM (synchronous management channel) PDO mapping object list. Multiple PDOs can be mapped in different sub- index.

In the servo drive of the SDA2 E series, one RPDO allocation and one TPDO allocation are supported, as shown in the following table:

Index	Sub-index	Content
0x1C12	01h	Choose to use one of 0x1600~0x1603 as the actual RPDO
0x1C13	01h	Choose to use one of 0x1A00~0x1A03 as the actual TPDO

The content of the PDO transmission does not include the protocol content. Each PDO determines the specific meaning of the data through the mapping object. The PDO mapping parameter contains pointers to the process data corresponding to the PDO that the PDO needs to send or receive, including the index, sub-index and mapping. Each PDO can map one or more objects simultaneously. The sub-index 0 records the number of objects mapped to the PDO, and the maximum is 10, and the sub-index 1~10 is the mapping content. The mapping parameter content is defined as follows.

bit	31	16	15	8	7	0
Content	Object index			Sub-index			Object length		

The index and the sub-index together determine the position of the object in the object dictionary, and the length of the object indicates the specific bit length of the object, expressed in hexadecimal.

For example:

Indicate that the mapping parameter for the 16-bit control word 6040h-00 is 60400010h.

The PDO mapping of the SDA2 E series servo is performed as follows (taking TPDO as an example):

1. Set 0x1c13 sub 0x00h to 0
2. Set 0x1a00 sub 0x00h to 0
3. Set 0x1a00 sub 0x01h~0x0ah
4. Set 0x1a00 sub 0x00h to the required number of TPDOs (1~10)
5. Set 0x1c13 sub 0x01h to 0x1a00
6. Set 0x1c13 sub 0x00h to 1

Note: The maximum data length of RPDO and TPDO is 32 bytes. When the total data of the mapping exceeds this size, it will not be able to switch to the SafeOP state.

3.5 Synchronous mode

The SDA2 E-Series servos support two synchronous modes: Free Run mode and DC Synchronous mode.

The synchronization mode can be viewed through the sub-index 1 of the object dictionary 0x1C32, but cannot be set manually. The servo will determine which mode the current servo enters according to the DC register configured by the master station during PS conversion.

3.5.1 DC Synchronization Mode

When the master station supports the DC synchronization function and the function is activated, the SDA2 E series servo will enter the DC synchronization mode after the PS conversion. When the master station configures the slave station, the time and transmission delay of each slave station are corrected by the DC clock to ensure that the time of the master station and all the slave stations are consistent. The slave will receive the data transmitted by the master station at the same time interval and send its own data.

a. Synchronization cycle time

The synchronization cycle time range is from 250us to 10ms. During PS conversion, the synchronization cycle time is automatically set according to the DC register configured by the master station. The synchronization cycle time can be queried through the sub-index 10 of the object dictionary 0x1C32.

b. Input shift time

Adjusting the offset time of the input data allows the master station to acquire input data at a specific time as needed.

At the DC synchronization time, after the input data offset time, the SDA2 E series servo will latch the input data and transmit it to the ESC chip, after which the master station can query the input data. By adjusting the input data offset time, the input data at the required time can be read as needed.

The input data offset time is set by sub-index 3 of the object dictionary 0x1C33, and the value is at least 26000 ns. When setting this value, the value of 62500 times should be added on the basis of 26000, otherwise it cannot be written. The maximum offset time can't exceed the time which subtracts 99,000 ns. When the PS is converted, it will check whether the offset value is exceeded. If it is exceeded, it cannot be switched to the SafeOP state.

The input data offset time can also be set by the servo parameter P4.09. The default value of this parameter is 0. After the setting, the servo needs to be powered on again to take effect. The calculation formula is as follows:

$$\text{Input data offset time} = 26000 + P4.09 * 62500$$

3.5.2 Free run mode

When the master station does not support the DC synchronization function or the DC function is not activated, the SDA2 E series servo will enter the free running mode after the PS conversion. The master station and the slave station have an asynchronous relationship, and each has a clock for independent calculation time. The commands transmitted and replied between the master station and the slave station only exchange commands according to their respective time periods. Therefore it does not have precise synchronization.

The synchronization cycle time of the free running mode is set by writing to the sub-index 2 of the object dictionary 0x1C32, and the synchronization time ranges from 1 ms to 10 ms. The synchronization time is that the SDA2 servo internally updates the data according to the set time, and has no relationship with the period of the host computer access.

3.6 Emergency object

When the SDA2 servo fails, if the current ESM state machine is not in the initialization state (Init), the emergency message mailbox data is sent to wait for the master station to query. The content of the emergency message is as follows:

Table 3-15 Emergency message frame structure

Byte	0	1	2	3	4	5	6	7
Content	Error code		Error register	Error number	Auxiliary code		reserved	

The error code and auxiliary error code definitions are detailed in Chapter 5.

3.7 Addressing mode

The addressing mode specified by EtherCAT is as follows

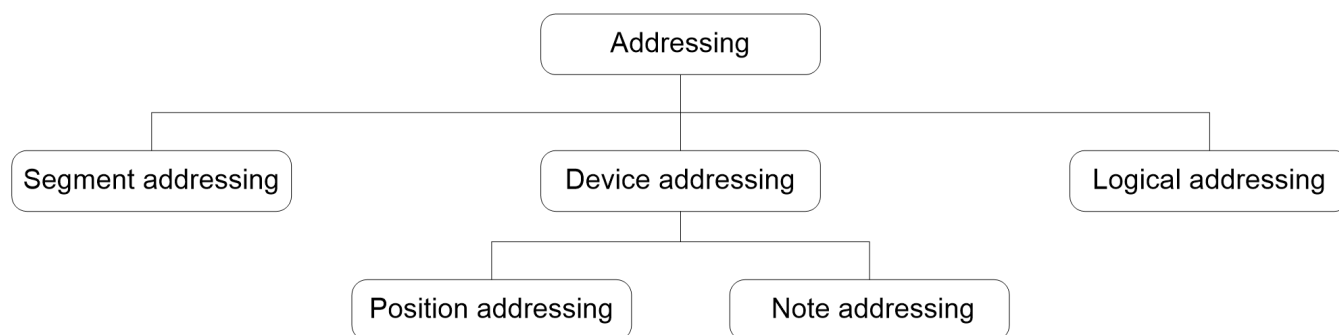

Device addressing for EtherCAT includes location addressing and node addressing. The location addressing is assigned by the master station according to the connection order of the slave devices. The node addressing can be assigned by the master station as needed or by the slave station by parameter assignment of the node address, and the master station then looks for a particular node by the node address.

The SDA2 E series servo node address can be set by the following two methods:

1. Parameter P4.02 is set to 0 (default). The servo will write the 0004h address (ConfigStationAlias) stored in the EEPROM to the ESC slave alias address register (0x0012) at startup. The node address stored in the EEPROM is from the master station configuration.
2. When parameter P4.02 is set to 1, the servo will write the node address value set in parameter P4.01 to the ESC slave alias address register (0x0012) at startup.

4.1 Control state machine

4.1.1 CiA402 state machine

The SDA2-E series driver must be used to guide the servo drive in accordance with the procedures specified in the standard 402 protocol, and the servo drive can be operated in the specified state.

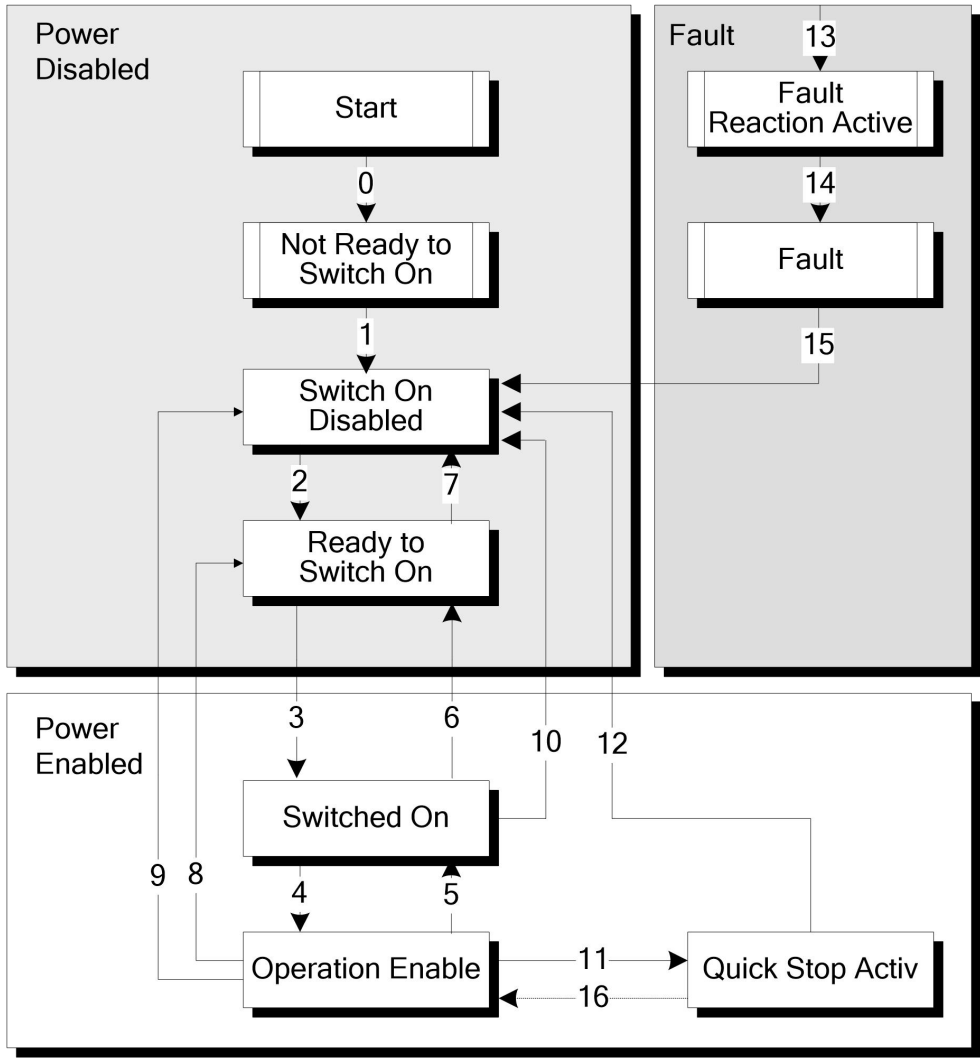

Figure 4-1 CiA402 state machine

4.1.2 Control words

The control word contains the following features:

1. Control state machine switching
2. Each mode related control
3. Manufacturer specific control word (SDA2 E series servo is not supported)

The specific bit-related functions of the control word are as follows:

Bit	Function	Description
0	Switch on	State machine control
1	Enable voltage	
2	Quick stop	
3	Enable operation	
4~6	Operation mode specific	Operation mode related
7	Fault reset	State machine control
8	Halt	Reserved
9~10	Reserved	
11~15	Manufacturer specific	

The state machine is triggered by the corresponding control commands consisting of 5 bits of bit 0~bit3 and bit7 of the control word.

Command	Control words function bit					state conversion (refer to figure 4-1)
	Fault reset	Enable operation	Quick stop	Enable voltage	Switch on	
Shutdown	0	X	1	1	0	2,6,8
Switch on	0	0	1	1	1	3
Disable voltage	0	X	X	0	X	7,9,10,12
Quick stop	0	X	0	1	X	7,10,11
Disable operation	0	0	1	1	1	5
Enable operation	0	1	1	1	1	4,16
Fault reset	↑	X	X	X	X	15

Note: the symbol X represents not affected by this bit, and the symbol ↑ represents the rising edge.

4.1.3 Status word

The state word contains the following features:

1. Indicate the current state machine state
2. Indicate the status of each mode
3. Manufacturer specific status (SDA2 E series servo is not supported)

The specific meanings of the state words are as follows:

Bit	Function	Description
0	Ready to switch on	State of state machine
1	Switched on	
2	Operation enabled	
3	Fault	
4	Voltage enabled	Servo is ready
5	Quick stop	State of state machine
6	Switch on disabled	
7	Warning	Warning
8	Manufacturer specific	Reserved
9	Remote	
10	Target reached	Operation mode related
11	Internal limit active	
12 - 13	Operation mode specific	
14 - 15	Manufacturer specific	Reserved

The status indication of the state machine is performed by Bit0~3 and bit5~6. The specific meanings are as follows:

Value (binary)	State
xxxx xxxx x0xx 0000	Not ready to switch on
xxxx xxxx x1xx 0000	Switch on disabled
xxxx xxxx x01x 0001	Ready to switch on
xxxx xxxx x01x 0011	Switched on
xxxx xxxx x01x 0111	Operation enabled
xxxx xxxx x00x 0111	Quick stop active
xxxx xxxx x0xx 1111	Fault reaction active
xxxx xxxx x0xx 1000	Fault

4.2 Profile position mode

Description

The servo drive receives the target position, the running speed, the acceleration/deceleration time and other information from the upper computer, and then controls the servo motor to reach the specified target position in a specified manner according to the received command.

Step:

1. Set [[Modes of Operation: 6060h] to Profile position mode (6060h = 01h).
2. Set [Target Position: 607Ah] as the target position. (Unit: unit quantity)
3. Set [Profile velocity: 6081h] to the running speed. (Unit: 0.1rpm)
4. Set [Profile Acceleration: 6083h] to the acceleration slope. (Unit: ms from 0 rpm to 2000 rpm)
5. Set [Profile Deceleration: 6084h] to the deceleration slope. (Unit: ms from 2000 rpm to 0 rpm)
6. Set [Control Word: 6040h], enable the servo according to the state machine, and set the position mode related control word.

Profile position mode related object dictionary

Index (HEX)	Sub Idx	Name	Unit	Data type	Data Attr	PDO map	Setting range	Default value
603F	0	Error Code	-	u16	RO	TPDO	-	0
6040	0	Control Word	-	u16	RW	Y	-	0
6041	0	Status Word	-	u16	RO	TPDO	-	0
605A	0	Quick stop Option Code	-	s16	RW	NO	0,1,5	0
6060	0	Modes of Operation	-	s8	RW	Y	0,1,3,4,6,8,9,10	0
6061	0	Modes of Operation Display	-	s8	RO	TPDO	-	0
6062	0	Position Demand Value	unit	s32	RO	TPDO	-	0
6063	0	Position Actual Pulse Value	pulse	s32	RO	TPDO	-	0
6064	0	Position Actual Value	unit	s32	RO	TPDO	-	0
6065	0	Maximal Following Error	rev/10	u32	RW	Y	0.1~100.0	15
6067	0	Position Window	unit	u32	RW	Y	0~200000	100
607A	0	Target Position	unit	s32	RW	Y	-2147483648 ~2147483647	0
607D	0	Software Position Limit	-	u8	RO	NO	2	2
	1	Min position limit	unit	s32	RW	Y	-200000000	-2000000000
	2	Max position limit	unit	s32	RW	Y	~2000000000	2000000000
607F	0	Maximal Profile Velocity	rpm/10*	u32	RW	Y	6000.0	3000.0
6080	0	Maximal Motor Speed	rpm/10	u32	RW	Y	6000.0	3000.0

Index (HEX)	Sub Idx	Name	Unit	Data type	Data Attr	PDO map	Setting range	Default value
6081	0	Profile Velocity	rpm/10*	u32	RW	Y	-6000.0~6000.0	0
6083	0	Profile Acceleration	ms	u32	RW	Y	1~999999	100
6084	0	Profile Deceleration	ms	u32	RW	Y	1~999999	100
6093	0	Position Factor	-	u8	RO	NO	2	2
	1	Position Factor Numerator	-	u32	RW	Y	1~4194303	16
	2	Position Factor Divisor	-	u32	RW	Y	1~4194303	1
60F4	0	Following Error Actual Value	unit	s32	RO	TPDO	-	0
60FC	0	Position Demand Pulse Value	pulse	s32	RO	TPDO	-	0

Note: Units with * can be switched by parameters

Profile position mode related control word

bit	Name	Description
15~7	-	Refer to 4.1
6	ABS/INC	When set to 1, the target position is an absolute value, and when it is 0, it is an incremental value.
5	Change set immediately	When set to 1, the data is immediately changed. If it is 0, it is not changed immediately.
4	New set point	If the data is immediately changed to 1, the new positioning operation is started immediately at the rising edge of the local position, otherwise the local position is only valid when the positioning is completed.
3~0	-	Refer to 4.1

Profile position mode related state word

Bit	Name	Description
15~14	-	Refer to 4.1
13	Following Error	The deviation between the feedback position and the command position is greater than the tolerance range
12	Set-point acknowledge	Ready to accept updates (overwriting) of the Target position.
11	Limiter activation	Servo motor position reaches limiter position
10	Target reached	The deviation between the feedback position and the command position is less than the set range, and the speed is in the zero speed range.
9~0	-	Refer to 4.1

4.3 Cycle Synchronized Position Mode

Description

The cycle synchronization mode is used to implement multi-axis synchronous control. According to the set synchronization period, the host sends the target position at the timing, and the servo calculates the position change value of each position loop period according to the synchronization period and the target position, and completes the position control as the position command. SDA2 E series servo drive only supports absolute position commands.

Steps

1. Set [Modes of Operation: 6060h] to the Cycle synchronized position mode (6060h = 08h).
2. Set [Control Word: 6040h] to enable the drive.
3. The host computer periodically sends the target position [Target position: 607Ah].

Cycle synchronized position mode related object dictionary:

Index (HEX)	Sub Idx	Name	Unit	Data type	Data Attr	PDO map	Setting range	Default value
603F	0	Error Code	-	u16	RO	TPDO	-	0
6040	0	Control Word	-	u16	RW	Y	-	0
6041	0	Status Word	-	u16	RO	TPDO	-	0
605A	0	Quickstop Option Code	-	s16	RW	NO	0,1,5	0
6060	0	Modes of Operation	-	s8	RW	Y	0,1,3,4,6,8,9,10	0
6061	0	Modes of Operation Display	-	s8	RO	TPDO	-	0
6062	0	Position Demand Value	unit	s32	RO	TPDO	-	0
6063	0	Position Actual Pulse Value	pulse	s32	RO	TPDO	-	0
6064	0	Position Actual Value	unit	s32	RO	TPDO	-	0
6065	0	Maximal Following Error	rev/10	u32	RW	Y	0.1~100.0	15
6067	0	Position Window	unit	u32	RW	Y	0~200000	100
607A	0	Target Position	unit	s32	RW	Y	-2147483648 ~2147483647	0
607D	0	Software Position Limit	-	u8	RO	NO	2	2
	1	Min position limit	unit	s32	RW	Y	-2000000000	-2000000000
	2	Max position limit	unit	s32	RW	Y	~2000000000	2000000000
6080	0	Maximal Motor Speed	rpm/10	u32	RW	Y	6000.0	3000.0
6093	0	Position Factor	-	u8	RO	NO	2	2
	1	Position Factor Numerator	-	u32	RW	Y	1~4194303	16
	2	Position Factor Divisor	-	u32	RW	Y	1~4194303	1

Index (HEX)	Sub Idx	Name	Unit	Data type	Data Attr	PDO map	Setting range	Default value
60F4	0	Following Error Actual Value	unit	s32	RO	TPDO	-	0
60FC	0	Position Demand Pulse Value	pulse	s32	RO	TPDO	-	0

Cycle synchronized position mode related control word

Bit	Name	Description
15~7	-	Refer to 4.1
6~4	None	None
3~0	-	Refer to 4.1

Cycle synchronized position mode related status word

Bit	Name	Description
15~14	-	Refer to 4.1
13	Following Error	The deviation between the feedback position and the command position is greater than the tolerance range
12	Successful synchronization	Synchronization cycle detection and synchronization data are normal
11	Limiter activation	Servo motor position reaches limiter position
10	Target reached	The deviation between the feedback position and the command position is less than the set range, and the speed is in the zero speed range.
9~0	-	Refer to 4.1

4.4 Homing Mode

Description

This mode helps the drive to find the homing location. The user can set the homing speed and homing method.

Steps

1. Set [Modes of Operation: 6060h] to the homing mode (6060h = 06h).
2. Set [Home Offset: 607Ch].
3. Set [Homing Method: 6098h], ranging from 1 to 37 (refer to the OD-6098h definition below).
4. Set [Homing Speed for Switch Search: 6099h Sub-1] . (Unit: 0.1rpm)
5. Set [Homing Speed for Zero Search: 6099h Sub-2] . (Unit: 0.1rpm)
6. Set [Control Word: 6040h] to power up the drive and let the motor run and start homing.

Homing mode related object dictionary:

Index (HEX)	Sub Idx	Name	Unit	Data type	Data Attr	PDO map	Setting range	Default value
603F	0	Error Code	-	u16	RO	TPDO	-	0
6040	0	Control Word	-	u16	RW	Y	-	0
6041	0	Status Word	-	u16	RO	TPDO	-	0
6060	0	Modes of Operation	-	s8	RW	Y	0,1,3,4,6,8,9,10	0
6061	0	Modes of Operation Display	-	s8	RO	TPDO	-	0
6062	0	Position Demand Value	unit	s32	RO	TPDO	-	0
607C	0	Home Offset	unit	s32	RW	Y	0~2000000000	1000
6098	0	Homing Method	-	s8	RW	Y	0~37	0
6099	0	Homing Speeds	-	u8	RO	NO	2	2
	1	Homing Speed for Switch Search	rpm/10	u32	RW	Y	0.1~6000.0	500
	2	Homing Speed for Zero Search	rpm/10	u32	RW	Y	0.1~6000.0	50

Homing mode related control word

Bit	Name	Description
15~7		Refer to 4.1
6~5	None	None
4	Start homing	Start homing (Rising edge valid)
3~0		Refer to 4.1

Homing mode related status word

Bit	Name	Description
15~14	-	Refer to 4.1
13	Homing error	1. Perform homing mode without setting the mode (6098h is 0) 2. Perform position preset when speed zero is not established (6098h is 35) 3. Perform homing if the servo is not enabled.
12	Homing done	Homing completed
11	None	None
10	Positioning completed	The deviation between the feedback position and the command position is less than the set range, and the speed is in the zero speed range.
9~0	-	Refer to 4.1

The SDA2 E series servo drive supports 37 kinds of homing methods. For details, see the following table:

Method no	Starting direction	Deceleration point signal	Homing signal	Homing offset position	Deceleration point Valid edge
1	negative	-OT	Z	positive	-
2	positive	+OT	Z	negative	-
3	Condition judge	LS	Z	negative	Falling edge
4		LS	Z	positive	Rising edge
5		LS	Z	positive	Falling edge
6		LS	Z	negative	Rising edge
7	The same to way 3				
8	The same to way 4				
9	positive	LS	Z	negative	Rising edge
10	positive	LS	Z	positive	Falling edge
11	The same to way 5				
12	The same to way 6				
13	negative	LS	Z	positive	Rising edge
14	negative	LS	Z	negative	Falling edge
15~16	Reserved				
17	negative	-	-OT	positive	-
18	positive	-	+OT	negative	-
19	Condition judge	-	LS	negative	Falling edge
20		-	LS	positive	Rising edge
21		-	LS	positive	Falling edge
22		-	LS	negative	Rising edge
23	The same to way 19				
24	The same to way 20				
25	positive	-	LS	negative	Rising edge
26	positive	-	LS	positive	Falling edge
27	The same to way 21				
28	The same to way 22				
29	negative	-	LS	positive	Rising edge
30	negative	-	LS	negative	Falling edge

Method no	Starting direction	Deceleration point signal	Homing signal	Homing offset position	Deceleration point Valid edge
31~34	Reserved				
35	Position preset				
36	positive	-	Stoppers	-	-
37	negative	-	Stoppers	-	-

Note 1: The position preset needs to be valid when the speed is within the zero speed range;

Note 2: The homing methods 36 and 37 need to cooperate with parameters P2.22 and P2.23.

Note 3: When the homing operation is running, the homing method cannot be switched, and the homing mode cannot be switched to another mode.

Note 4: LS means Deceleration point signal input.

Note 5: OT means overtravel.

4.5 Profile Velocity Mode

Description

The drive can receive speed commands and plan acceleration and deceleration.

Steps

1. Set [Modes of Operation: 6060h] to the speed control mode (6060h = 03h).
2. Set [Control Word: 6040h] to start the servo and let the motor run.
3. Set [Profile Acceleration: 6083h] and [Profile Deceleration: 6084h] to plan the slope. (Unit: ms from 0 rpm to 2000 rpm)
4. Set [Target Velocity: 60FFh].

Profile Velocity Mode Related Object Dictionary:

Index (HEX)	Sub Idx	Name	Unit	Data type	Data Attr	PDO map	Setting range	Default value
603F	0	Error Code	-	u16	RO	TPDO	-	0
6040	0	Control Word	-	u16	RW	Y	-	0
6041	0	Status Word	-	u16	RO	TPDO	-	0
6060	0	Modes of Operation	-	s8	RW	Y	0,1,3,4,6,8,9,10	0
6061	0	Modes of Operation Display	-	s8	RO	TPDO	-	0
606B	0	Velocity Demand Value	rpm/10*	s32	RO	TPDO	-	0
606C	0	Velocity Actual Value	rpm/10*	s32	RO	TPDO	-	0
606D	0	Velocity Window	rpm	u16	RW	Y	10~6000	50
606F	0	Velocity Threshold	rpm	u16	RW	Y	10~6000	50

Index (HEX)	Sub Idx	Name	Unit	Data type	Data Attr	PDO map	Setting range	Default value
607F	0	Maximal Profile Velocity	rpm/10*	u32	RW	Y	0.01~6000.0	3000.0
6080	0	Maximum Motor Speed	rpm/10	u32	RW	Y	0.01~6000.0	3000.0
6083	0	Profile Acceleration	ms	u32	RW	Y	1~999999	100
6084	0	Profile Deceleration	ms	u32	RW	Y	1~999999	100
60FF	0	Target Velocity	rpm/10*	s32	RW	Y	-6000.0~+6000.0	0

Note: Units with * can be switched by parameters

Profile Velocity Mode related control word

Bit	Name	Description
15~7	-	Refer to 4.1
6~4	None	None
3~0	-	Refer to 4.1

Profile Velocity Mode related status word

Bit	Name	Description
15~14	-	Refer to 4.1
13~12	None	None
11	Speed zero	Feedback speed is in the speed zero range
10	Speed arrival	The difference between the feedback speed and the command speed is within the speed arrival
9~0	-	Refer to 4.1

4.6 Cycle Synchronized Speed mode

Description

The drive can receive the speed command, and the acceleration and deceleration are planned by the host controller.

Steps

1. Set [Modes of Operation: 6060h] to the speed control mode (6060h = 03h).
2. Set [Control Word: 6040h] to start the servo and let the motor run.
3. The host controller periodically settings [Target Velocity : 60FFh].

Cycle Synchronized Speed mode Related Object Dictionary:

Index(HEX)	Sub Idx	Name	Unit	Data type	Data Attr	PDO map	Setting range	Default value
603F	0	Error Code	-	u16	RO	TPDO	-	0
6040	0	Control Word	-	u16	RW	Y	-	0
6041	0	Status Word	-	u16	RO	TPDO	-	0
6060	0	Modes of Operation	-	s8	RW	Y	0,1,3,4,6,8,9,10	0
6061	0	Modes of Operation Display	-	s8	RO	TPDO	-	0
606B	0	Velocity Demand Value	rpm/10*	s32	RO	TPDO	-	0
606C	0	Velocity Actual Value	rpm/10*	s32	RO	TPDO	-	0
606D	0	Velocity Window	rpm	u16	RW	Y	10~6000	50
606F	0	Velocity Threshold	rpm	u16	RW	Y	10~6000	50
6080	0	Maximal Motor Speed	rpm/10	u32	RW	Y	0.01~6000.0	3000.0
60FF	0	Target Velocity	rpm/10*	s32	RW	Y	-6000.0~+6000.0	0

Note: Units with * can be switched by parameters.

Cycle Synchronized Speed mode related control word

Bit	Name	Description
15~7		Refer to 4.1
6~4	None	None
3~0		Refer to 4.1

Cycle Synchronized Speed mode related status word

Bit	Name	Description
15~14	-	Refer to 4.1
13	None	None
12	Successful synchronization	Synchronization cycle detection and synchronization data are normal
11	Speed zero	Feedback speed is within the speed zero range
10	Speed arrival	The difference between the feedback speed and the command speed is within the speed arrival
9~0	-	Refer to 4.1

4.7 Profile Torque Mode

Description

The drive can receive torque commands.

Steps

1. Set [Modes of Operation: 6060h] to torque control mode (6060h = 04h).
2. Set [Control Word: 6040h] to start the servo and let the motor run.
3. Set [Target Torque: 6071h] to the target torque. (Unit: one thousandth of rated torque)

Profile Torque Mode related object dictionary:

Index (HEX)	Sub Idx	Name	Unit	Data type	Data Attr	PDO map	Setting range	Default value
603F	0	Error Code	-	u16	RO	TPDO	-	0
6040	0	Control Word	-	u16	RW	Y	-	0
6041	0	Status Word	-	u16	RO	TPDO	-	0
6060	0	Modes of Operation	-	s8	RW	Y	0,1,3,4,6,8,9,10	0
6061	0	Modes of Operation Display	-	s8	RO	TPDO	-	0
6071	0	Target Torque	1‰	s16	RW	Y	-300.0%~300.0%	0
6074	0	Torque Demand Value	1‰	s16	RO	TPDO	-300.0%~300.0%	0
6078	0	Current Actual Value	1‰	s16	RO	TPDO	-300.0%~300.0%	0

Profile Torque Mode related control word

Bit	Name	Description
15~7		Refer to 4.1
6~4	None	None
3~0		Refer 4.1

Profile Torque Mode related status word

Bit	Name	Description
15~14		Refer to 4.1
13~10	None	None
9~0		Refer to 4.1

4.8 Cycle Synchronized Torque Mode

Description

The drive can receive torque commands periodically.

Steps

1. Set [Modes of Operation: 6060h] to torque control mode (6060h = 04h).
2. Set [Control Word: 6040h] to start the servo and let the motor run.
3. The host computer is set periodically [target torque: 6071h]. (Unit: one thousandth of rated torque)

Cycle Synchronized Torque Mode related object dictionary:

Index (HEX)	Sub Idx	Name	Unit	Data type	Data Attr	PDO map	Setting range	Default value
603F	0	Error Code	-	u16	RO	TPDO	-	0
6040	0	Control Word	-	u16	RW	Y	-	0
6041	0	Status Word	-	u16	RO	TPDO	-	0
6060	0	Modes of Operation	-	s8	RW	Y	0,1,3,4,6,8,9,10	0
6061	0	Modes of Operation Display	-	s8	RO	TPDO	-	0
6071	0	Target Torque	1‰	s16	RW	Y	-300.0%~300.0%	0
6074	0	Torque Demand Value	1‰	s16	RO	TPDO	-300.0%~300.0%	0
6078	0	Current Actual Value	1‰	s16	RO	TPDO	-300.0%~300.0%	0

Cycle Synchronized Torque Mode related control word

Bit	Name	Description
15~7	-	Refer to 4.1
6	None	None
3~0	-	Refer to 4.1

Cycle Synchronized Torque Mode related status word

Bit	Name	Description
15~14	-	Refer to 4.1
13	None	None
12	Successful synchronization	Synchronization cycle detection and synchronization data are normal
11~10	None	None
9~0	-	Refer to 4.1

4.9 Other mode

4.9.1 Position Touch Probe

The position Touch Probe function can be used to latch the position of the servo motor feedback via an external IO (EXT) or encoder Z-phase signal.

Position Touch Probe related object dictionary:

Index (HEX)	Sub Idx	Name	Unit	Data type	Data Attr	PDO map	Setting range	Default value
60B8	0	Touch Probe Function	-	u16	RW	Y	-	0
60B9	0	Touch Probe Status	-	u16	RO	TPDO	-	0
60BA	0	Touch probe pos1 pos value	unit	s32	RO	TPDO	-2147483648 ~ 2147483647	0
60BB	0	Touch probe pos1 neg value	unit	s32	RO	TPDO		0
60BC	0	Touch probe pos2 pos value	unit	s32	RO	TPDO		0
60BD	0	Touch probe pos2 neg value	unit	s32	RO	TPDO		0

When the Touch Probe function is executed by the external IO, the EXT1 function corresponds to the EI6 terminal, and the EXT2 corresponds to the EI7 terminal. To use the corresponding EXT function, the parameter P3.06 = 40 and P3.07=41 need to be set. When the EXT latch is turned on, an action error alarm is triggered if the corresponding parameter is not set.

Touch Probe function bit description:

Bit	Function	Description
0	TP1 enable	0:TP1 Disable 1:TP1 Enable
1	TP1 trigger mode	0: Single trigger (valid for the first trigger) 1: Continuous trigger
2	TP1 trigger signal selection	0: EXT1 1: Encoder Z phase
3	Reserved	Reserved
4	TP1 Rising edge latch enable	0: Disable 1: Enable
5	TP1 Falling edge latch enable	0: Disable 1: Enable
6~7	Reserved	Reserved
8	TP2 enable	0: Disable 1: Enable
9	TP2 trigger mode	0: Single trigger (valid for the first trigger) 1: Continuous trigger

Bit	Function	Description
10	TP2 trigger signal selection	0: EXT2 1: Encoder Z phase
11	Reserved	Reserved
12	TP2 rising edge latch enable	0: Disable 1: Enable
13	TP2 falling edge latch enable	0: Disable 1: Enable
14~15	Reserved	Reserved

Note: When the trigger signal is set to the Z phase, there is no difference between the rising edge and the falling edge, as long as one of the selections is enabled.

Touch Probe status bit description:

Bit	Function	Description
0	TP1 enable status	0: Not enabled 1: Enabled
1	TP1 rising edge latched status	0: Not latched 1: Latched
2	TP1 falling edge latched status	0: Not latched 1: Latched
3~5	Reserved	Reserved
6	TP1 trigger signal monitoring	0: EXT1 Trigger 1: Encoder Z phase trigger
7	TP1 latched toggle	The state of this bit is toggled each time when a valid position is latched
8	TP2 enable status	0: Not enabled 1: Enabled
9	TP2 rising edge latched status	0: Not latched 1: Latched
10	TP2 falling edge latched status	0: Not latched 1: Latched
11~13	Reserved	Reserved
14	TP2 trigger signal monitoring	0: EXT2 Trigger 1: Encoder Z phase trigger
15	TP2 latched toggle	The state of this bit is toggled each time when a valid position is latched

Chapter 5 Troubleshooting

5.1 Error code

When the drive has error, the drive sends an emergency message to the network, including the fault-related content, as shown in the following table.

Table 5-1 Communication error code

Error category	Error disp	Error content	Error code	Error No.	Auxiliary code*	Error reset
General error	OC1	Over current 1	2311h	01h	8006h	YES
	OC2	Over current 2	2312h	02h	8006h	YES
	OS	Over speed	8400h	03h	8007h	YES
	HV	Over voltage	3210h	05h	8009h	YES
	ET1	Encoder error 1	7305h	06h	0008h	NO
	ET2	Encoder error 2	7305h	07h	000Ah	NO
	CT	Control power supply abnormal	FF00h	08h	000Ah	NO
	DE	Data error	5530h	09h	000Dh	NO
	cE	Encoder combination error	7120h	0Bh	0011h	NO
	EC	Encoder communication error	7305h	0Dh	8010h	YES
	CTE	EI Repeat assignment	6320h	0Eh	0013h	NO
	OL1	Over load 1	3230h	0Fh	8001h	YES
	OL2	Over load 2	3230h	10h	8001h	YES
	LVP	Main circuit power is insufficient	3220h	21h	8009h	YES
	RH3	Regenerative resistor overheating 3	4210h	24h	0004h	NO
	OF	Deviation exceeded	8611h	25h	8005h	YES
	AH	Drive overheating	4210h	26h	8003h	YES
	dL1	ABS Data loss 1	7305h	28h	0015h	NO
	dL2	ABS Data loss 2	7305h	29h	0015h	NO
	dL3	ABS Data loss 3	7305h	2Ah	0015h	NO
EtherCAT error	Hr	ECAT Hardware error	8500h	30h	001Ah	NO
	SEE	SII EEPROM error	8501h	31h	001Ah	NO
	LL	Link disconnection	8502h	32h	801Ah	YES
	Pto	PDO Watchdog timeout	8100h	33h	801Bh	YES
	cS	Sync signal error	8101h	34h	801Bh	YES
	cSD	Cycle Synchronized data error	8102h	35h	801Bh	YES
	PLF	PLL Phase- locking failure	8103h	36h	801Bh	YES
	PLL	PLL Phase lock loss	8104h	37h	801Bh	YES

Error category	Error disp	Error content	Error code	Error No.	Auxiliary code*	Error reset
EtherCAT error	oPE	Control mode setting error	8800h	38h	801Ch	YES
	ESr	ESM Request error	8801h	39h	801Ch	YES
	Act	Action error protection	8802h	3Ah	801Ch	YES

* The highest bit of the auxiliary code indicates whether the current error can be reset (1: Can be reset 0: Cannot be reset)

5.2 EtherCAT Associated error details

This section only records information about EtherCAT-related errors. For general faults, please refer to the drive manual.

When an EtherCAT association fault is detected, both the AL Status Code and the ESM state machine are updated to the appropriate state based on the current fault. The AL Status Code and ESM state machine are not changed when a generic fault occurs.

1) ECAT Hardware error

Cause	ECAT Related hardware error PDI Interface access error	
Solution	Re-appear after re-powering, replace the drive	
Related information	ESM status to be detected	ALL
	ESM status after error	Init
	Syn mode to be detected	ALL
	AL Status Code	0x0000
	Fault indicator led status	ON
	Error reset	NO

2) SII EEPROM Error

Cause	SII EEPROM Load error or access error	
Solution	Update the SII EEPROM data. If the power is still on after the update, the drive will be replaced.	
Related information	ESM status to be detected	ALL
	ESM status after error	Init
	Syn mode to be detected	ALL
	AL Status Code	0x0051
	Fault indicator led status	Blinking
	Error reset	NO

3) Link disconnected

Cause	When the ESM state machine is not in the Init status, the link is detected to be disconnected (the input port link is disconnected)	
Solution	Check the communication cable. Check if there is a problem with the superior output device.	
Related information	ESM status to be detected	PreOP、 SafeOP、 OP
	ESM status after error	Init
	Syn mode to be detected	ALL
	AL Status Code	0x0000
	Fault indicator led status	Blinking
	Error reset	YES

4) PDO Watchdog timeout

Cause	PDO data is not received when the PDO communication exceeds the time set by the ESC registers 0x400 and 0x420.	
Solution	Check if the PDO from the host device is interrupted PDO watchdog detection time is set to more than 2 times the synchronization period Check if there is a problem with the wiring of the EtherCAT communication cable. Check if there is excessive noise on the EtherCAT communication cable	
Related information	ESM status to be detected	SafeOP、 OP
	ESM status after error	SafeOP
	Syn mode to be detected	ALL
	AL Status Code	0x001B
	Fault indicator led status	Single flashing
	Error reset	YES

5) Synchronized signal error

Cause	SYNC signal is out of synchronization with servo	
Solution	Confirm DC settings Check if the propagation delay compensation and offset compensation are correct	
Related information	ESM status to be detected	SafeOP、 OP
	ESM status after error	SafeOP
	Syn mode to be detected	DC Synchronized
	AL Status Code	0x002C
	Fault indicator led status	Single flashing
	Error reset	YES

6) Cycle synchronized data error

Cause	Received valid data within the specified time in cycle synchronization mode	
Solution	Confirm the data and cycle of the PDO sent by the host device Confirm whether the set value of parameter P4.03 is in the demand range Check if there is excessive noise on the EtherCAT communication cable	
Related information	ESM status to be detected	OP
	ESM status after error	SafeOP
	Syn mode to be detected	DC Synchronized
	AL Status Code	0x002C
	Fault indicator led status	Single flashing
	Error reset	YES

7) PLL Phase-locking failure

Cause	After the phase-locking process starts 2s. EtherCAT sync signal and servo PLL lock still cannot be completed.	
Solution	Confirm DC settings Check if the propagation delay compensation and offset compensation are correct	
Related information	ESM status to be detected	SafeOP
	ESM status after error	PreOP
	Syn mode to be detected	DC Synchronized
	AL Status Code	0x002D
	Fault indicator led status	Single flashing
	Error reset	YES

8) PLL Phase-locking loss

Cause	After the PLL Phase-locking is successful, the phase deviation is detected to be too large.	
Solution	Confirm DC settings Check if the propagation delay compensation and offset compensation are correct	
Related information	ESM status to be detected	OP
	ESM status after error	SafeOP
	Syn mode to be detected	ALL
	AL Status Code	0x0032
	Fault indicator led status	Single flashing
	Error reset	YES

9) Control mode setting error

Cause	When 0x6061 is 0, switch the Cia402 state machine to the Operation Enable state. Switching control mode during the homing operation (0x6060)	
Solution	Confirm the setting value of 0x6060 Confirm the timing of switching operation mode	
Related information	ESM status to be detected	PreOP、 SafeOP、 OP
	ESM status after error	Keep current state
	Syn mode to be detected	ALL
	AL Status Code	0x0000
	Fault indicator led status	OFF
	Error reset	YES

10) ESM Request error

Cause	Switch the ESM status when the Cia402 state machine is in the Operation Enable status or the Quick Stop Active status.	
Solution	Confirm the status transition request of the host controller	
Related information	ESM status to be detected	PreOP、 SafeOP、 OP
	ESM status after error	ESM status to be switched
	Syn mode to be detected	ALL
	AL Status Code	0x0000
	Fault indicator led status	OFF
	Error reset	YES

11) Action error protection

Cause	When the input signal EXT1\EXT2 is not assigned, the probe triggers selection EXT1\EXT2 In the cycle sync position mode, the difference between the input position command and the last position command is too large.	
Solution	Confirm Touch Probe selection Confirm the assignment of the EXT1\EXT2 signal Confirm that the position command is correct	
Related information	ESM status to be detected	PreOP、 SafeOP、 OP
	ESM status after error	Keep current state
	Syn mode to be detected	ALL
	AL Status Code	0x0000
	Fault indicator led status	OFF
	Error reset	YES

5.3 SDO Abort code

When accessing the drive over SDO , some errors may occur. At this point, the drive will reply to the SDO abort code. The specific meanings are shown in the following table.

Table 5-2 SDO abort code

Abort code	Cause
06010000	Object does not support access
06010001	Trying to read only write objects
06010002	Trying to write a read-only object
06020000	Object does not exist in the object dictionary
06040041	Object cannot be mapped to PDO
06040042	The number and length of mapped objects exceeds the PDO length
06070010	Data type does not match, service parameter length does not match
06070012	Data type does not match, service parameter length is too long
06070013	Data type does not match, service parameter length is too short
06090011	Subindex does not exist
06090030	Range of values outside the parameter value
06090031	Write parameter value is too large
06090032	Write parameter value is too small
08000000	General error
08000021	Data cannot be transmitted due to local control

Chapter6 Object Dictionary

6.1 Communication parameter object

The 1000h object group contains the parameters required for EtherCAT communication, and the communication parameters are not NO mapped to PDO.

Table 6-1 Communication parameter object

Index (HEX)	Sub Idx	Name	Unit	Data type	Data Attr	PDO map	Setting range	Default value
1000	0	Device type	-	u32	RO	NO	-	0x00000192
1001	0	Error register	-	u8	RO	NO	-	0
1008	0	Device name	-	string	RO	NO	-	2S0.75E
1009	0	Hardware version	-	string	RO	NO	-	1.0
100A	0	Software version	-	string	RO	NO	-	1.0
1018	0	Identity	-	u8	RO	NO	-	4
	1	Vendor ID	-	u32	RO	NO	-	0x000007E6
	2	Product code	-	u32	RO	NO	-	0x53444132
	3	Revision	-	u32	RO	NO	-	0x00190013
	4	Serial number	-	u32	RO	NO	-	0x00000000
1600 ~ 1603	0	Number of Mapped RxPDO	-	u8	RW	NO	0~10	-
	1	1st RxPDO Mapped Object	-	u32	RW	NO	-	-
	2	2nd RxPDO Mapped Object	-	u32	RW	NO	-	-
	3	3rd RxPDO Mapped Object	-	u32	RW	NO	-	-
	4	4th RxPDO Mapped Object	-	u32	RW	NO	-	-
	5	5th RxPDO Mapped Object	-	u32	RW	NO	-	-
	6	6th RxPDO Mapped Object	-	u32	RW	NO	-	-
	7	7th RxPDO Mapped Object	-	u32	RW	NO	-	-
	8	8th RxPDO Mapped Object	-	u32	RW	NO	-	-
	9	9th RxPDO Mapped Object	-	u32	RW	NO	-	-
	10	10th RxPDO Mapped Object	-	u32	RW	NO	-	-

Index (HEX)	Sub Idx	Name	Unit	Data type	Data Attr	PDO map	Setting range	Default value
1A00 ~ 1A03	0	Number of Mapped TxPDO	-	u8	RW	NO	0~10	-
	1	1st TxPDO Mapped Object	-	u32	RW	NO	-	-
	2	2nd TxPDO Mapped Object	-	u32	RW	NO	-	-
	3	3rd TxPDO Mapped Object	-	u32	RW	NO	-	-
	4	4th TxPDO Mapped Object	-	u32	RW	NO	-	-
	5	5th TxPDO Mapped Object	-	u32	RW	NO	-	-
	6	6th TxPDO Mapped Object	-	u32	RW	NO	-	-
	7	7th TxPDO Mapped Object	-	u32	RW	NO	-	-
	8	8th TxPDO Mapped Object	-	u32	RW	NO	-	-
	9	9th TxPDO Mapped Object	-	u32	RW	NO	-	-
	10	10th TxPDO Mapped Object	-	u32	RW	NO	-	-
1C00	0	Sync manager type	-	u8	RO	NO	-	4
	1	Sync manager 0	-	u8	RO	NO	-	1
	2	Sync manager 1	-	u8	RO	NO	-	2
	3	Sync manager 2	-	u8	RO	NO	-	3
	4	Sync manager 3	-	u8	RO	NO	-	4
1C12	0	Sync Manager RxPDO Assign	-	u8	RW	NO	0~1	1
	1	Index of Assigned RxPDO	-	u16	RW	NO	0x1600~ 0x1603	0x1600
1C13	0	Sync Manager TxPDO Assign	-	u8	RW	NO	0~1	1
	1	Index of Assigned TxPDO	-	u16	RW	NO	0x1A00~ 0x1A03	0x1A00
1C32	0	SM output parameter	-	u8	RO	NO	-	32
	1	Synchronization Type	-	u16	RO	NO	-	2
	2	Cycle Time	ns	u32	RW	NO	1000000~ 10000000	1000000
	3	Shift Time	ns	u32	RO	NO	-	45000
	4	Synchronization Types supported	-	u16	RO	NO	-	5

Index (HEX)	Sub Idx	Name	Unit	Data type	Data Attr	PDO map	Setting range	Default value
	5	Minimum Cycle Time	ns	u32	RO	NO	-	120000
	6	Calc and Copy Time	ns	u32	RO	NO	-	45000
	7	Minimum Delay Time	ns	u32	RO	NO	-	0
	8	Get Cycle Time	-	u16	RO	NO	-	0
	9	Delay Time	ns	u32	RO	NO	-	0
	10	Sync0 Cycle Time	ns	u32	RO	NO	-	0
	32	Sync Error	-	bool	RO	NO	-	FALSE
1C33	0	SM input parameter	-	u8	RO	NO	-	32
	1	Synchronization Type	-	u16	RO	NO	-	2
	2	Cycle Time	ns	u32	RW	NO	1000000~ 10000000	1000000
	3	Shift Time	ns	u32	RW	NO	26000~ 9901000	26000
	4	Synchronization Types supported	-	u16	RO	NO	-	5
	5	Minimum Cycle Time	ns	u32	RO	NO	-	120000
	6	Calc and Copy Time	ns	u32	RO	NO	-	94000
	7	Minimum Delay Time	ns	u32	RO	NO	-	0
	8	Get Cycle Time	-	u16	RO	NO	-	0
	9	Delay Time	ns	u32	RO	NO	-	0
	10	Sync0 Cycle Time	ns	u32	RO	NO	-	0
	32	Sync Error	-	bool	RO	NO	-	FALSE

6.2 Sub-protocol object

The 6000h object group contains the supported sub-protocols CiA 402 related objects.

Table 6-2 CiA 402 Sub-protocol Objects

Index (HEX)	Sub Idx	Name	Unit	Data type	Data Attr	PDO map	Setting range	Default value
603F	0	Error Code	-	u16	RO	TPDO	-	0
6040	0	Control Word	-	u16	RW	YES	-	0
6041	0	Status Word	-	u16	RO	TPDO	-	0
605A	0	Quickstop Option Code	-	s16	RW	NO	0,1,5	0
6060	0	Modes of Operation	-	s8	RW	YES	0,1,3,4,6,8,9,10	0
6061	0	Modes of Operation Display	-	s8	RO	TPDO	-	0
6062	0	Position Demand Value	unit	s32	RO	TPDO	-	0
6063	0	Position Actual Pulse Value	pulse	s32	RO	TPDO	-	0
6064	0	Position Actual Value	unit	s32	RO	TPDO	-	0
6065	0	Maximal Following Error	rev	u32	RW	YES	100~104857600	1310720
6067	0	Position Window	unit	u32	RW	YES	0~200000	100
606B	0	Velocity Demand Value	rpm/10*	s32	RO	TPDO	-6000.0~+6000.0	0
606C	0	Velocity Actual Value	rpm/10*	s32	RO	TPDO		0
606D	0	Velocity Window	rpm	u16	RW	YES	10~6000	50
606F	0	Velocity Threshold	rpm	u16	RW	YES	10~6000	50
6071	0	Target Torque	1‰	s16	RW	YES	-300.0%~300.0%	0
6074	0	Torque Demand Value	1‰	s16	RO	TPDO	-300.0%~300.0%	0
6077	0	Torque Actual Value	1‰	s16	RO	TPDO		0
6078	0	Current Actual Value	1‰	s16	RO	TPDO		0
607A	0	Target Position	unit	s32	RW	YES	-2147483648~2147483647	0
607C	0	Home Offset	unit	s32	RW	YES	0~2000000000	1000
607D	0	Software Position Limit	-	u8	RO	NO	2	2
	1	Min position limit	unit	s32	RW	YES	-2147483648~2147483647	-2000000000
	2	Max position limit	unit	s32	RW	YES		2000000000

Index (HEX)	Sub Idx	Name	Unit	Data type	Data Attr	PDO map	Setting range	Default value
607F	0	Maximal Profile Velocity	rpm/10*	u32	RW	YES	6000.0	3000.0
6080	0	Maximal Motor Speed	rpm/10	u32	RW	YES	6000.0	3000.0
6081	0	Profile Velocity	rpm/10*	u32	RW	YES	-6000.0~ 6000.0	0
6083	0	Profile Acceleration	ms	u32	RW	YES	1~999999	100
6084	0	Profile Deceleration	ms	u32	RW	YES	1~999999	100
6086	0	Motion Profile Type	-	s16	RW	NO	0	0
6093	0	Position Factor	-	u8	RO	NO	2	2
	1	Position Factor Numerator	-	u32	RW	YES	1~4194303	16
	2	Position Factor Divisor	-	u32	RW	YES	1~4194303	1
6098	0	Homing Method	-	s8	RW	YES	0~37	0
6099	0	Homing Speeds	-	u8	RO	NO	2	2
	1	Homing Speed for Switch Search	rpm/10	u32	RW	YES	0.1~6000.0	500
	2	Homing Speed for Zero Search	rpm/10	u32	RW	YES	0.1~6000.0	50
60B0	0	Position offset	unit	s32	RW	YES	-2147483648 ~2147483647	0
60B8	0	Touch Probe Function	-	u16	RW	YES	-	0
60B9	0	Touch Probe Status	-	u16	RO	TPDO	-	0
60BA	0	Touch probe pos1 pos value	unit	s32	RO	TPDO	-2147483648 ~ 2147483647	0
60BB	0	Touch probe pos1 neg value	unit	s32	RO	TPDO		0
60BC	0	Touch probe pos2 pos value	unit	s32	RO	TPDO		0
60BD	0	Touch probe pos2 neg value	unit	s32	RO	TPDO		0
60F4	0	Following Error Actual Value	unit	s32	RO	TPDO	-	0
60FC	0	Position Demand Pulse Value	pulse	s32	RO	TPDO	-	0
60FF	0	Target Velocity	rpm/10*	s32	RW	YES	-6000.0~ 6000.0	0
6502	0	Supported Drive Modes	-	u32	RO	TPDO	0x6D	0x6D

Note: Units with * can be switched by parameters..

6.3 Servo specific object

The object dictionary 3000h~4001h is a unique object of the SDA2-E series servo driver.

Table 6-3 SDA2 specific objects

Index (HEX)	Sub Idx	Name	Unit	Data type	Data Attr	PDO map	Setting range	Default value
3000	0	Number of Servo Para Group1	-	u8	RO	NO	-	99
	1~99	Servo Parameter Group 1	-	s32	RW	NO	Refer to servo parameter	
3001	0	Number of Servo Para Group2	-	u8	RO	NO	-	99
	1~99	Servo Parameter Group 2	-	s32	RW	NO	Refer to servo parameter	
3002	0	Number of Servo Para Group3	-	u8	RO	NO	-	99
	1~99	Servo Parameter Group 3	-	s32	RW	NO	Refer to servo parameter	
3003	0	Number of Servo Para Group4	-	u8	RO	NO	-	99
	1~99	Servo Parameter Group 4	-	s32	RW	NO	Refer to servo parameter	
3100	0	Number of Monitor Data	-	u8	RO	NO	-	18
	1	Feedback Speed	rpm	s32	RO	NO	-	-
	2	Command Speed	rpm	s32	RO	NO	-	-
	3	Command Torque	0.01	s32	RO	NO	-	-
	4	Peak Toque	0.01	s32	RO	NO	-	-
	5	Motor Current	0.1A	s32	RO	NO	-	-
	6	Effective Torque	0.01	s32	RO	NO	-	-
	7	Feedback Postion	unit	s32	RO	NO	-	-
	8	Command Postion	unit	s32	RO	NO	-	-
	9	Postion Deviation	-	s32	RO	NO	-	-
	10	Command Pulse Frequency	0.1KHz	s32	RO	NO	-	-
	11	Feedback Cumulative Pulse	pulse	s32	RO	NO	-	-
	12	Cumulative Input Pulse	pulse	s32	RO	NO	-	-
	13	LS-Z Pulse	pulse	s32	RO	NO	-	-
	14	Load Inertia Ratio		s32	RO	NO	-	-
	15	DC Link Voltage(max.)	V	s32	RO	NO	-	-
	16	DC Link Voltage(min.)	V	s32	RO	NO	-	-
	17	VREF Input Voltage	0.01V	s32	RO	NO	-	-
18	TREF Input Voltage	0.01V	s32	RO	NO	-	-	

Index (HEX)	Sub Idx	Name	Unit	Data type	Data Attr	PDO map	Setting range	Default value
3200	0	Alarm Record Select	-	u8	RW	NO	1~20	1
3201	0	Number of Alarm Record	-	u8	RO	NO	14	14
	1	Alarm Code	-	s32	RO	NO	-	0
	2	Total Time Main Power Supply	h	s32	RO	NO	-	0
	3	Reserve	-	s32	RO	NO	-	0
	4	Motor Running Time	-	s32	RO	NO	-	0
	5	Feedback Speed	rpm	s32	RO	NO	-	0
	6	Feedback Speed(5ms before)	rpm	s32	RO	NO	-	0
	7	Command Speed	rpm	s32	RO	NO	-	0
	8	Command Torque	1%	s32	RO	NO	-	0
	9	Motor Current	1%	s32	RO	NO	-	0
	10	Effective Torque	1%	s32	RO	NO	-	0
	11	DC Link Voltage	V	s32	RO	NO	-	0
	12	EC Error Count	-	s32	RO	NO	-	0
	13	Command Position	unit	s32	RO	NO	-	0
	14	Sequence Mode	-	s32	RO	NO	-	0
3300	0	Position offset	uint	s32	RW	YES	-2 ³² ~2 ³²	0
4000	0	EI signal	-	u8	RO	NO	-	2
	1	Hardware EI signal	-	u8	RO	TPDO	0~0xFF	0
	2	Communication EI signal	-	u16	RW	Y	0~0xFFFF	0
4001	0	EOUT signal	-	u8	RO	NO	-	2
	1	Hardware EOUT signal	-	u8	RO	TPDO	0~0xFF	0
	2	Communication EOUT signal	-	u16	RO	TPDO	0~0xFFFF	0

The unique objects of the SDA2 servo drive are as follows:

Table 6-4 SDA2 specific object function correspondence table

Index high byte	Corresponding content	Index low byte	Sub-index
30h	Parameters	Corresponding content group	Sub-items for each set of content
31h	Monitoring data		
32h	Alarm record		
33h	Application		
40h	Digital terminal		

For example, parameter P1.52 is the first group of parameters, the corresponding object dictionary index is 0x3000, and the sub index is 52.

6.3.1 Parameters

The servo drive parameters are accessed through the object dictionary 3000h~3003h. The data type of all parameters is s32 (signed 32-bit data). The specific meaning of the parameters refers to the sixth chapter of the drive user manual.

6.3.2 Monitoring data

The SDA2 E series servo drive provides 18 sets of related monitoring data and are accessed via the object 3100h.

6.3.3 Alarm record

The SDA2 E series servo drive provides historical alarm data viewing. It can query all relevant data of the alarm time. Through the object dictionary 3200h and 3201h, you can select to view 20 sets of historical alarm data. Each group of alarm records contains 14 related data.

Note: The corresponding meaning of the sub-index 04h (motor power-on time) corresponds to the following:

When the value is greater than 32768, the valid value is the value after subtracting 32768, and the corresponding unit is hour;

When the value is less than 32768, the valid value is the current value, and the corresponding unit is second.

6.3.4 Application

The function of Object 0x3300 is the position offset. When writing this value, the written value is used as the current position value after offset, and the read value is the position value after offset. This function does not modify the feedback position value, only affects itself.

6.3.5 Digital terminal

You can view the status of the digital terminals of the servo drive, including hardware terminals and communication terminals. Only communication EI is writable.

The hardware EI corresponds to the 8 hardware digital inputs, and the corresponding functions are set by parameters P3.01~P3.08.

The communication EI expands 16 communication digital inputs, and the corresponding functions are set by parameters P3.09~P3.24.

The hardware EOUT corresponds to the five hardware digital outputs, and the corresponding functions are set by parameters P3.51~P3.55.

The communication EOUT expands 16 communication digital outputs, and the corresponding functions are set by parameters P3.56~P3.71.

For details, please refer to Chapter 6 of the servo user manual.

- Innovate for more | win forever
- Industry intelligence | Energy saving | Green power



Savch wechat
Service Number

Quanzhou Factory

Address: 3# Zixin Road, Jiangnan Hi-Tech Industrial Park,
Quanzhou, Fujian, China
Tel: 0595-24678267 Fax: 0595-24678203

Service Network

Website: www.savch.net

Qualification

Received ISO9001 and CE recognition

All rights reserved. Subject to change without further notice.

Sales service contact address

